





STATIONARY BATTERY INSTALLATION AND OPERATING INSTRUCTIONS















4-1034

DANGER Lead Acid Battery Contains: Lead, Sulfuric Acid (Electrolyte), Lead Compounds.

Harmful if swallowed, inhaled, or in contact with skin.
 Acid causes severe skin burns and eye damage.
 May damage fertility or the unborn child if ingested or inhaled.
 May cause harm to breast-fed children.
 May cause cancer if ingested or inhaled.
 Causes skin irritation, serious eye damage.
 Contact with internal components may cause irritation or severe burns.
 Causes damage to central nervous system, blood and kidneys through prolonged or repeated exposure if ingested or inhaled.
 Irritating to eyes, respiratory system, and skin.
 May form explosive air/gas mixture during charging.
 Extremely flammable gas (hydrogen). Explosive, fire, blast or projection hazard.
 Obtain special instructions before use.
 Do not handle until all safety precautions have been read and understood.
 Wash thoroughly after handling.
 Do not eat drink or smoke when using this product.
 Avoid contact during pregnancy/while nursing.

Wear protective gloves/protective clothing, eye protection/face protection.
 Use only outdoors or in a well-ventilated area.
 Avoid contact with internal acid.
 Do not breathe dust/fume/gas/mist/vapors/spray.
 Keep away from heat/sparks/open flames/hot surfaces. No smoking.
IF SWALLOWED OR CONSUMED: rinse mouth. Do NOT induce vomiting.
 Call a poison center/doctor if you feel unwell.
IF ON CLOTHING OR SKIN (or hair): Remove/Take off immediately all contaminated clothing and wash it before reuse. Rinse skin with water/shower.
IF INHALED: Remove person to fresh air and keep comfortable for breathing. Immediately call a POISON CENTER or doctor/physician.
IF IN EYES: Rinse cautiously with water for several minutes. Remove contact lenses, if present and easy to do. Continue rinsing.
 If exposed/concerned, or if you feel unwell seek medical attention/advice.
 Store locked up, in a well-ventilated area, in accordance with local and national regulation.
 Dispose of contents/container in accordance with local and national regulation.
 Keep out of reach of children.



Pb

PROPOSITION 65 WARNING: battery posts, terminals and related accessories contain lead and lead compounds, chemicals known to the State of California to cause cancer and reproductive harm. Batteries also contain other chemicals known to the State of California to cause cancer. **WASH HANDS AFTER HANDLING.**

WARNING: Risk of fire, explosion or burns. Do not disassemble or incinerate. Not recommended for inverted use. Follow product charging instructions. **High Voltage:** Risk of shock. Do not touch uninsulated terminals or connectors.

Do Not Remove Vent Valve

Manufactured by: East Penn Manufacturing Co.
 102 Deka Road, Lyon Station, PA 19536 USA 610-682-6361 **Lead Acid Battery Electrolyte (Sulfuric Acid)**

BATTERIES AND OTHER RELATED PARTS CONTAIN LEAD

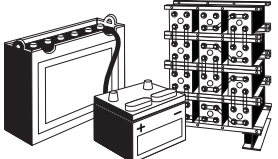

WARNING:

Battery posts, terminals and related accessories contain lead and lead compounds, chemicals known to the State of California to cause cancer and reproductive harm. Batteries also contain other chemicals known to the State of California to cause cancer. **WASH HANDS AFTER HANDLING!**

Form No. 1214 Rev. 6/08 Must be posted in workstation near battery.

IN REFERENCE TO THIS MANUAL:

- "Battery" is defined as an individual 12-volt unit.
- "Battery string" is defined as a series connected electrical system comprised of batteries (individual 12-volt units).

SAFETY PRECAUTIONS

VRLA (Valve Regulated Lead-Acid) batteries have the electrolyte immobilized within the battery; however, electrical hazard associated with batteries still exists. **Work performed on these batteries should be done with the tools and the protective equipment listed below.** VRLA battery installations should be supervised by personnel familiar with batteries and battery safety precautions.

WARNING: Risk of fire, explosion or burns. Do not disassemble, heat above 40°C, or incinerate.

Protective Equipment

Although VRLA batteries can vent or leak small amounts of electrolyte, electrical safety is the principal but not the only concern for safe handling. Per IEEE 1188 recommendations, the following minimum set of equipment for safe handling of the battery and protection of personnel shall be available:

1. **Safety glasses with side shields, or goggles, or face shields as appropriate. (Consult application specific requirements)**
2. Electrically insulated gloves, appropriate for the installation.
3. Protective aprons and safety shoes.
4. Portable or stationary water facilities in the battery vicinity for rinsing eyes and skin in case of contact with acid electrolyte.
5. Class C fire extinguisher.
6. Acid neutralizing agent.
7. Adequately insulated tools (as defined by IEEE 1188).
8. Lifting devices of adequate capacity, when required.

Procedures

The following safety procedures should be followed during installation:

(Always wear safety glasses with side shields or face shield goggles when working on or near batteries.)

1. These batteries are sealed and contain no free electrolyte. Under normal operating conditions, they do not present any sulfuric acid danger. However, if the battery jar or cover is damaged, sulfuric acid could be present. **Sulfuric acid is harmful to the skin and eyes. Flush affected area with water immediately and consult a physician if splashed in the eyes.**
2. **Prohibit smoking and open flames, and avoid arcing in the immediate vicinity of the battery.**
3. Do not wear metallic objects, such as jewelry or key chains, while working on batteries. Do not store uninsulated tools in pockets or tool belt while working in vicinity of battery.
4. Keep the top of the battery dry and clear of tools and other foreign objects.
5. Provide adequate ventilation (**per IEEE standard 1187 and/or Federal, State & Local codes**) and follow recommended charging voltages.
6. Never remove or tamper with the pressure relief valves. Warranty void if vent valve is removed.
7. Inspect all flooring and lifting equipment for functional adequacy.
8. Adequately secure battery, racks, or cabinets to the floor.
9. Connect support structures to ground system in accordance with applicable codes.
10. The below IEEE Standards contain additional information. Other standards may be relevant to your specific application.

IEEE 1184 – Guide for Batteries for UPS Systems

IEEE 1187 – Recommended Practice for Installation Design of VRLA Batteries

IEEE 1188 – Recommended Practice for Maintenance, Testing, of VRLA Batteries

IEEE 1189 – Selection of VRLA Batteries for Stationary Applications

RECEIVING & STORAGE

Receiving Inspection

Upon receipt, and at the time of actual unloading, each package should be visually inspected for any possible damage or electrolyte leakage. If either is evident, a more detailed inspection of the entire shipment should be conducted and noted on the bill of lading. Record receipt date, inspection data and notify carrier of any damage.

Unpacking

1. **Always wear eye protection.**
2. Check all batteries for visible defects such as cracked containers, loose terminal posts, or other unrepairable problems. Batteries with these defects must be replaced.
3. Check the contents of the packages against the packaging list. Report any missing parts or shipping damage to your East Penn agent or East Penn Mfg. Co. immediately.
4. Never lift batteries by the terminal posts.

Storage

1. Batteries should be stored indoors in a clean, level, dry, cool location. Recommended storage temperature is 0°F to 90°F (-18°C to 32°C).
2. Stored lead-acid batteries self discharge and must be given a boost charge to prevent permanent performance degradation.

0°F to 77°F (-18°C to 25°C) storage:

Batteries should be recharged six months from date of manufacture.

>77°F (25°C) storage:

Use the chart below for recharge intervals. Voltage readings should be taken on a monthly basis. Batteries that reach 12.60V per battery should be recharged regardless of scheduled interval. Record dates and conditions for all charges during storage.

3. If a boost charge is required: the recommended charge is 24 hours at a constant voltage equal to 14.40V per battery.
4. Do not store beyond 12 months.

Fig. 2 Recharge Interval Chart

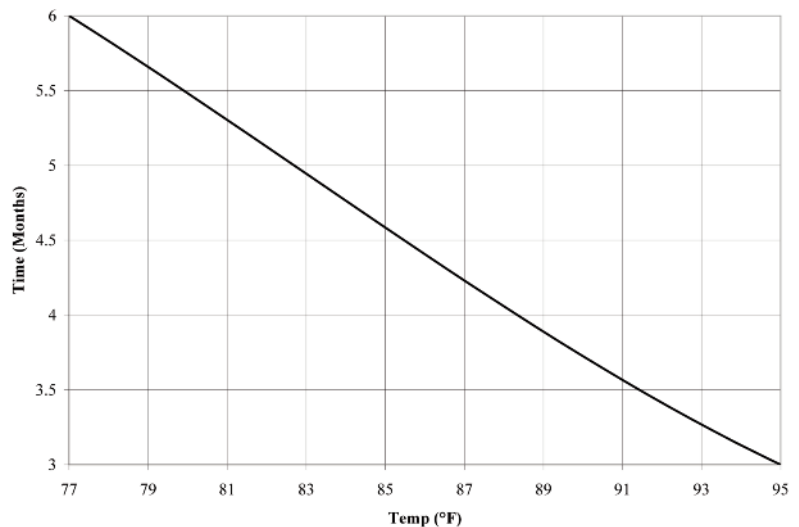

INSTALLATION

General

Caution should be taken when installing batteries to insure no damage occurs. The battery string cabinet, tray, rack, etc. shall be inspected for sharp edges that could cause damage to the battery casing. Batteries shall not be dropped, slid, or placed on rough or uneven surfaces such as tray lips or grated flooring. Mishandling of batteries could result in equipment damage or human injury. East Penn will not be liable for damage or injury as a result of mishandling or misuse of the product.

Grounding

When grounding the battery string, proper techniques should be applied per electrical standards such as NEC and/or Federal, State and Local codes, as well as User Manual of specific application.

Cabinets

Cabinet systems come factory assembled and prewired. Do not tip or turn cabinets on their sides when positioning them in their intended installation area. Cabinets must be used in an upright position. These systems are preconnected. Only inter-shelf, inter-cabinet and connections to the load are required. See the connection diagram inside the cabinet. Inter-cabinet and load connection cables are not included.

Racks

Assemble racks in accordance with the intended arrangement, align with a level and bolt to the floor. See rack assembly instructions.

UNIGY HR BATTERIES ARE TESTED AND APPROVED TO BE INSTALLED AND OPERATED IN THEIR UPRIGHT POSITION.

TOP TERMINAL BATTERY

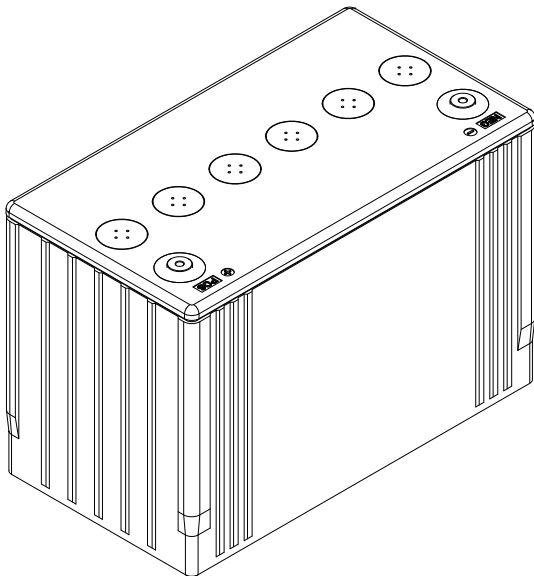

Terminals – Upright Position

FRONT TERMINAL BATTERY

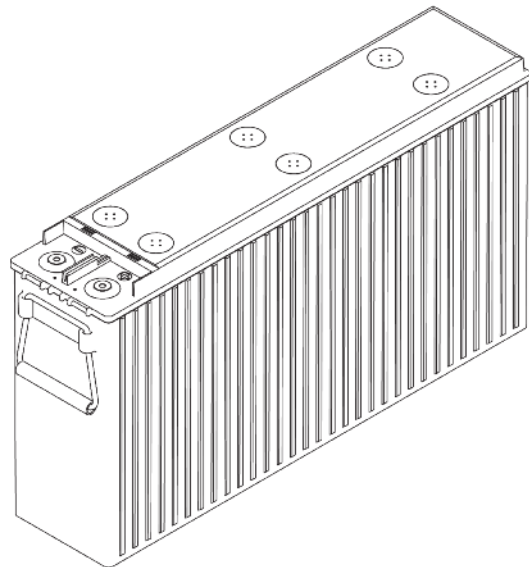

Terminals – Upright / Front Position

**FOR ANY OTHER INSTALLATION ORIENTATION,
THE PRODUCT WILL NOT BE WARRANTED.**

BATTERY ASSEMBLY

(ALWAYS WEAR EYE PROTECTION.)

1. Set up the battery string so that the positive post (+) of one battery is connected to the negative post (-) of the next battery for all series connections.
2. For future identification, individual batteries should be numbered in electrical connection sequence, beginning with number one (1) at the positive end of the battery string.
3. The interbattery connector contact surfaces shall be cleaned by rubbing gently with a non-metallic brush or pad before installing connectors. **Only approved oxide inhibitors may be applied to connectors or battery posts.**⁽¹⁾
4. Install all interbattery connectors using lockwasher and bolts loosely to allow for final alignment of batteries, then torque to **100 ± 5 in lb (11.3 ± .5 newton meters).**
DO NOT OVERTORQUE.
5. After torquing the connections on racked batteries, read the voltage of the battery string to assure that individual batteries are connected correctly. The total voltage should be approximately equal to the number of batteries times the measured voltage of one battery (when connected in series). If the measurement is less, recheck the connections for proper voltage and polarity.
6. Read and record interbattery connection resistance and note the method of measurement. This helps determine a satisfactory initial installation and can be used as a reference for future maintenance requirements. See **Battery Maintenance Report (Pg. 8 – Appendix C)** Clean, remake and remeasure any connection having a resistance measurement greater than 10% of the average of all the same type of connections (interbattery, inter-tier or shelf, inter-rack or inter-cabinet).
7. Battery performance is based on the output at the battery terminals. Therefore, the shortest electrical connections between the battery string and the operating equipment results in maximum total battery string performance.

Do not select cable size on current carrying capability only. Cable size should not provide a greater voltage drop between the battery system and operating equipment than specified. Excess voltage drop will reduce the desired support time of the battery system.

⁽¹⁾ **Approved oxide inhibitors:**
No-Ox-ID “A” from Sanchem Inc.

SYSTEM OPERATIONS

Charger Voltage

These batteries are designed for continuous float applications.

FLOAT / STANDBY (Per Battery)

13.50V ± 0.06 @ 77°F (25°C)

When setting the float voltage on the charger, the battery string should be set to float at the nominal battery float voltage times the number of batteries in the string. The charger must be able to maintain the system voltage within ± 0.5% of the desired level at all times. The desired float voltage varies with temperature. Consult **Voltage Compensation Chart (Pg. 6 – Appendix A)**.

Charger Current

Charge current should not exceed the recommended min. & max. requirement.

Consult Appendix B for min. & max. charge current limits.

TEMPERATURE COMPENSATION

Battery voltage should be adjusted for ambient temperature variations.

12mV per °C (1.8°F) per 12V battery

Consult **Voltage Compensation Chart (Pg. 6 – Appendix A)** for temperature compensation voltage maximum and minimum limits.

Battery Voltage

Although the charger must maintain the system voltage within ± 0.5%, individual battery voltages may vary by ± 0.30V per battery of the average battery string float voltage.

Equalizing

Upon installation of the battery string, an optional charge of 14.40V per battery ± 0.06 @ 77°F (25°C) for 24 hours (not to exceed 24 hours) can be applied. (NOTE: Verify that the higher battery voltage will not adversely affect any other connected equipment). If this is done, be sure to reset the charging equipment to the proper float voltage.

Battery Operation

Battery operating temperature will affect battery string capacity and operating life.

Temperatures greater than 77°F (25°C) will reduce the operating life of the battery. For every 13°F (7°C) increase in operating temperature above 77°F (25°C), the warranty period will be proportionally reduced by 50% as shown below:

Operating Temperature		Proportional Percentage (%) of Life
°F	°C	
77	25	100%
81	27	80%
87	30	60%
90	32	50%

The battery string operating temperature should not exceed 95°F (35°C) and should never exceed 105°F (40.5°C) for more than an eight-hour period. **If operating temperatures are expected to be in excess of 95°F (35°C), contact East Penn for recommendations.**

Discharging at temperatures less than 77°F (25°C) will reduce the capacity of the battery. **If operating temperatures are expected to be less than 50°F (10°C), contact East Penn for recommendations.**

The battery string must be located in a manner that the individual batteries do not vary by more than 5°F (2.8°C) between the lowest and highest individual battery temperatures.

Rectifier Ripple Voltage

FREQUENCY

Ripple that has a frequency greater than 667Hz (duration less than 1.5ms) is acceptable, unless it is causing additional battery heating.

Ripple that has a frequency less than 667Hz (duration greater than 1.5ms), must meet the following voltage specification to be acceptable.

VOLTAGE SPECIFICATION

Ripple voltage shall be less than 0.5% peak to peak of the manufacturer's recommended battery string voltage.

Failure to comply can void the warranty.

RECORD KEEPING

Voltages, Temperatures & Ohmic

READINGS

Record keeping is an important part of stationary battery maintenance and warranty coverage. This information will help in establishing a life history of the battery string and inform the user if and when corrective action needs to be taken. Consult **Battery Maintenance Report (Pg.8 – Appendix C)**.

While it is acceptable to operate at temperatures less than 77°F (25°C), it will require longer charging time to become fully recharged. Also, the capacity will be less at operating temperatures below 77°F (25°C).

After installation and when the battery string has been on float charge for one week, the following data should be recorded:

1. Battery string voltage at battery terminals while battery is on float charge.
2. Charger voltage at charger panel meter.
3. Individual battery float voltages.
4. Ambient temperatures within area of battery string.
5. Terminal connections should be checked to verify that the installer did torque all connections properly to **100 ± 5 in lb (11.3 ± .5 newton meters)** for proper torque values. Micro-ohm readings should be taken across every connection. Refer to meter manufacturer's instructions for proper placement of probes. If any reading differs by more than **20%** from its initial installation value, re-torque the connection, to **100 ± 5 in lb (11.3 ± .5 newton meters)** for proper torque values. **If reading remains high, clean contact surfaces according to Step 2 under Battery Assembly.**

Failure to maintain proper records including information as detailed above may result in voiding any applicable warranty.

MAINTENANCE

Always wear eye protection when working on or near batteries. Keep sparks and open flames away from batteries at all times. Review **Safety Precautions (Pg. 1)**

Annual Inspection ⁽¹⁾

1. Conduct a visual inspection of each battery.
2. Record the battery string voltage at battery terminals while battery is on float charge.
3. Record the charger voltage at charger panel meter.
4. Record the individual battery voltages. The accuracy of the DMM (Digital Multimeter) must be 0.05% (on dc scale) or better. The DMM must be calibrated to NIST traceable standards. Because float readings are affected by discharge and recharges, these readings must be taken when the battery string has been on continuous, uninterrupted float for at least one month. Battery should be within ± 0.30 volts of the average battery string float voltage.
5. Record the ambient temperatures.
6. Record the battery string temperature at the negative terminal.
7. Record individual battery Ohmic readings.
8. Record all interbattery and terminal connection resistances. Micro-ohm readings should be taken during this inspection. If any reading differs by more than 20% from initial readings taken, retorque the connection. Retorque value is equal to initial torque value as indicated in BATTERY ASSEMBLY section. Recheck the micro-ohm reading. If the reading remains high, clean the contact surface according to installation portion of this manual.

⁽¹⁾ **Other Maintenance Inspection intervals follow IEEE 1188**

Battery Cleaning

Batteries, cabinets, and racks, should be cleaned with clear water, a mixture of baking soda and water or East Penn Mfg supplied battery cleaner (part # 00321).

Never use solvents to clean the battery.

Capacity Testing

Per IEEE 1188 "Capacity testing is used to trend battery aging. The result of a capacity test is a calculation of the capacity of the battery. The calculated capacity is also used to determine if the battery requires replacement."

When performing capacity testing and recording data refer to IEEE 1188 recommendations.

NOTE: When discharging at higher rates, extra connectors may need to be added to prevent excessive voltage drop and / or excessive temperature rise.

Should it be determined that any individual battery(ies) need to be replaced, contact East Penn.

APPENDIX A

VOLTAGE COMPENSATION CHART

°C	Float Voltage per Battery	°F
≥35	13.38	≥95
34	13.39	93.2
33	13.40	91.4
32	13.42	89.6
31	13.43	87.8
30	13.44	86.0
29	13.45	84.2
28	13.46	82.4
27	13.48	80.6
26	13.49	78.8
25	13.50	77.0
24	13.51	75.2
23	13.52	73.4
22	13.54	71.6
21	13.55	69.8
20	13.56	68.0
19	13.57	66.2
18	13.58	64.4
17	13.60	62.6
16	13.61	60.8
15	13.62	59.0
14	13.63	57.2
13	13.64	55.4
12	13.66	53.6
11	13.67	51.8
≤10	13.68	≤50

12mV per °C per 12V battery

APPENDIX B

CHARGE CURRENT LIMITS

Battery Type	Max. Charge Current (A)	Min. Charge Current (A)**
U1HR1500	5.3	6.1
45HR2000	8.3	2.5
24HR3000	12.7	3.8
27HR3500	15.5	4.7
31HR4000	17.0	5.1
31HR5000	23.6	7.1
HR3000	13.3	4.0
HR3500	16.1	4.8
HR4000	17.2	5.2
HR5500	24.4	7.3
HR3500ET	17.2	5.2
HR5500ET	27.1	8.1
4DHR6500	32.7	9.8
HR7000ET	34.0	10.2
HR7500ET	37.0	11.1

** = Using minimum charge current will extend recharge time and increase risk of battery being undercharged

APPENDIX C

BATTERY MAINTENANCE REPORT

Inspection Date _____
 Company _____
 Address _____
 Battery location and/or number _____

No. of Units/String _____
 Type _____
 Date New _____
 Date Installed _____

Individual Battery Readings

Charger Output _____ Amp Air Temperature _____ °F
 Total Battery String Voltage _____ Panel Meter Volts _____

Unit No.	Volts	Ohms or Mhos	Unit No.	Volts	Ohms or Mhos	Unit No.	Volts	Ohms or Mhos	Unit No.	Volts	Ohms or Mhos	Unit No.	Volts	Ohms or Mhos	Unit No.	Volts	Ohms or Mhos
1			41			81			121			161			201		
2			42			82			122			162			202		
3			43			83			123			163			203		
4			44			84			124			164			204		
5			45			85			125			165			205		
6			46			86			126			166			206		
7			47			87			127			167			207		
8			48			88			128			168			208		
9			49			89			129			169			209		
10			50			90			130			170			210		
11			51			91			131			171			211		
12			52			92			132			172			212		
13			53			93			133			173			213		
14			54			94			134			174			214		
15			55			95			135			175			215		
16			56			96			136			176			216		
17			57			97			137			177			217		
18			58			98			138			178			218		
19			59			99			139			179			219		
20			60			100			140			180			220		
21			61			101			141			181			221		
22			62			102			142			182			222		
23			63			103			142			183			223		
24			64			104			144			184			224		
25			65			105			145			185			225		
26			66			106			146			186			226		
27			67			107			147			187			227		
28			68			108			148			188			228		
29			69			109			149			189			229		
30			70			110			150			190			230		
31			71			111			151			191			231		
32			72			112			152			192			232		
33			73			113			153			193			233		
34			74			114			154			194			234		
35			75			115			155			195			235		
36			76			116			156			196			236		
37			77			117			157			197			237		
38			78			118			158			198			238		
39			79			119			159			199			239		
40			80			120			160			200			240		
Avg. Voltage			Avg. Voltage			Avg. Voltage			Avg. Voltage			Avg. Voltage			Avg. Voltage		

Readings Taken By _____ Remarks/Recommendations _____

Readings should be taken at installation and annually thereafter.



e-mail: reservepowersales@dekabatteries.com www.dekabatteries.com



East Penn Manufacturing Co.

Lyon Station, PA 19536-0147

Phone: 610-682-3263

Fax: 610-682-0891